

TA2P

series

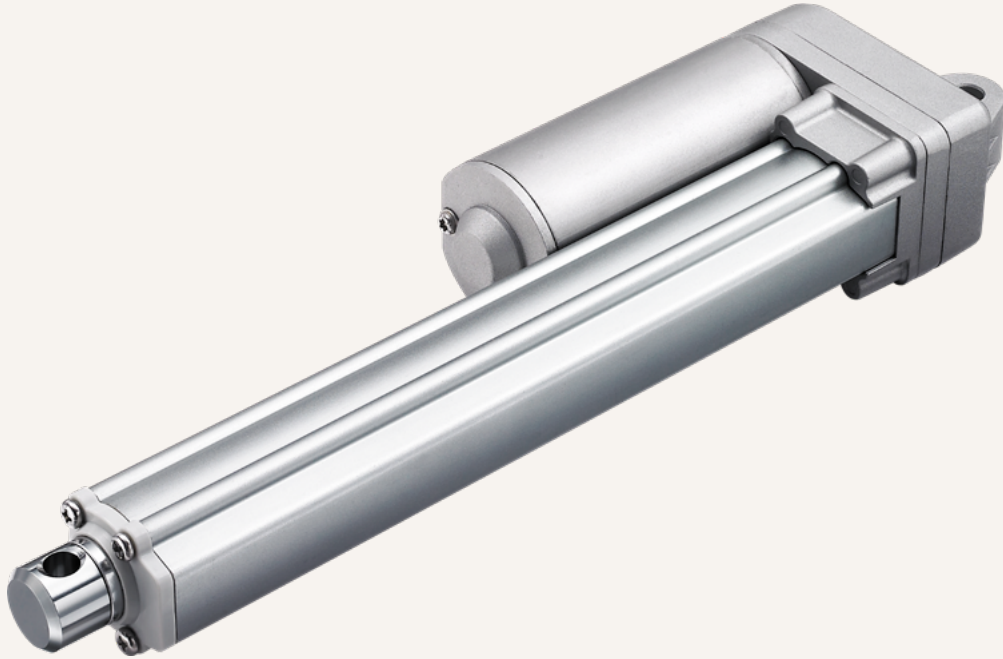

Product Segments

- **Industrial Motion**

Both the TA2 and the TA2P are compact, robust, and capable of performing well in certain outdoor environments. A more powerful motor makes the TA2P capable of handling load ratings up to 3500N (787 pounds) while retaining its compact size. In addition to the high power motor, the TA2P linear actuator is available with multiple choices for feedback sensors. Industry certifications for the TA2P linear actuator include IEC / ES 60601-1 and UL73.

General Features

Max. load	3,500N (push) 2,000N (pull)
Max. speed at max. load	2.4mm/s
Max. speed at no load	56.5mm/s
Retracted length	≥ Stroke + 108mm (with Hall sensors or without output signals)
IP rating	IP66D
Certificate	IEC60601-1, ES60601-1, EN 61000-6-1, EN 61000-6-3, UL73
Stroke	20~1000mm
Options	POT, Reed or Hall sensors
Voltage	12/24/36V DC; 12/24V DC (PTC)
Color	Silver
Operational temperature range	-25°C ~ +65°C
Operational temperature range at full performance	+5°C ~ +45°C

Drawing

Dimensions
without Output Signal
or with Hall Sensors
(mm)

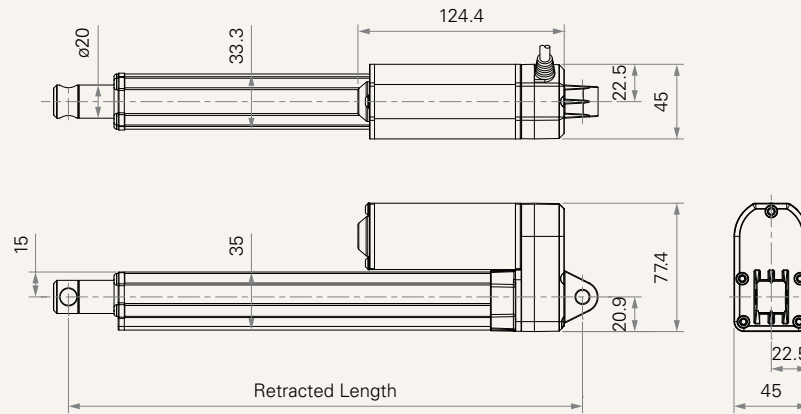

Dimensions
with POT
or Reed Sensor
(mm)

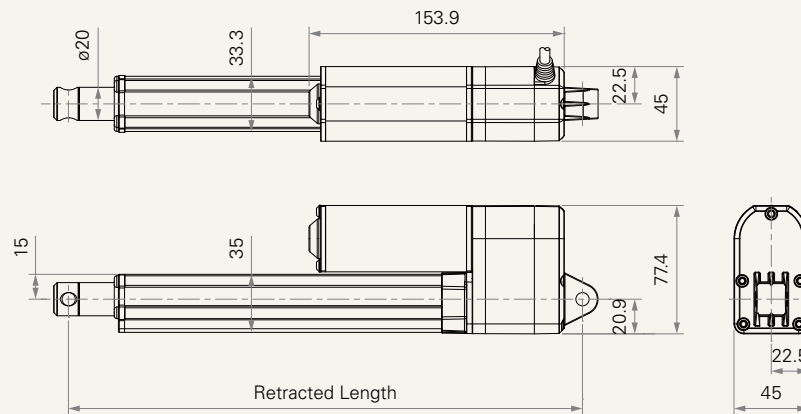

Load and Speed

CODE	Load (N)		Self Locking Force (N)	Typical Current (A)		Typical Speed (mm/s)	
	Push	Pull		No Load 24V DC	With Load 24V DC	No Load 24V DC	With Load 24V DC
Motor Speed (5200RPM, duty cycle 25%)							
A	250	250	250	1.2	2.3	43.0	36.0
B	500	500	500	1.1	2.5	25.8	23.0
C	1000	1000	1000	1.1	3.0	14.0	11.8
D	1500	1500	1500	1.0	2.8	9.0	8.0
E	2000	2000	2000	1.0	2.8	7.1	6.2
Motor Speed (6600RPM, duty cycle 25%)							
F	250	250	250	1.6	3.0	56.5	45.0
G	500	500	500	1.5	3.0	32.5	28.5
H	1000	1000	1000	1.5	3.0	16.5	14.3
K	1500	1500	1500	1.3	3.0	11.1	10.0
L	2000	2000	2000	1.3	3.0	8.8	7.7
Motor Speed (3800RPM, duty cycle 25%)							
S	3500	2000	3500	0.8	2.8	3.2	2.4
Motor Speed (2200RPM, duty cycle 25%)							
T	2000	2000	2000	0.3	0.9	3.2	2.3

Note

- 1 Please refer to the approved drawing for the final authentic value.
- 2 This self-locking force level is reached only when a short circuit is applied on the terminals of the motor. All the TiMOTION control boxes have this feature built-in.
- 6 The current & speed in table are tested with 24V DC motor. With a 12V DC motor, the current is approximately twice the current measured in 24V DC. With a 36V DC motor, the current is approximately two-thirds the current measured in 24V DC. Speed will be similar for all the voltages.
- 7 The current & speed in table are tested when the actuator is extending under push load.
- 8 The current & speed in table and diagram are tested with a stable 24V DC power supply.
- 9 Standard stroke: Min. ≥ 20 mm, Max. please refer to below table.

CODE	Load (N)	Max Stroke (mm)
A, F	≤ 250	1000
B, G	≤ 750	800
C, H	≤ 1000	600
D, K	≤ 1500	500
E, L, T	≤ 2000	450
S	≤ 3500	300

Performance Data (24V DC)

Motor Speed (5200RPM, duty cycle 25%)

Speed vs. Load

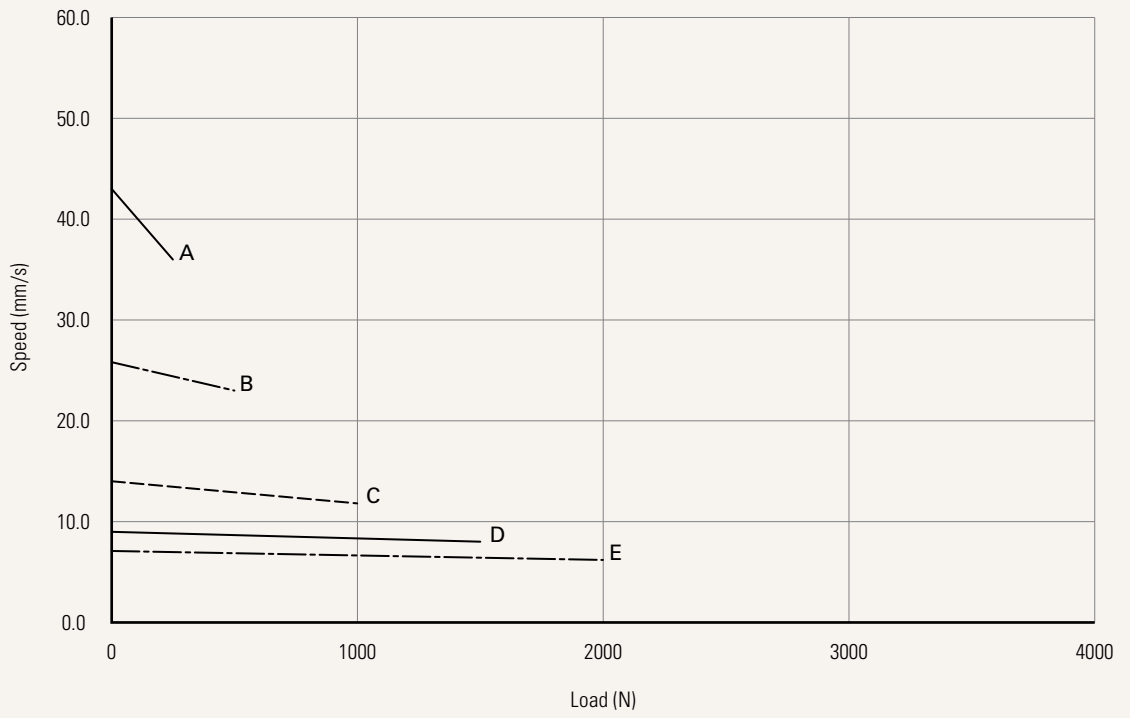

Current vs. Load

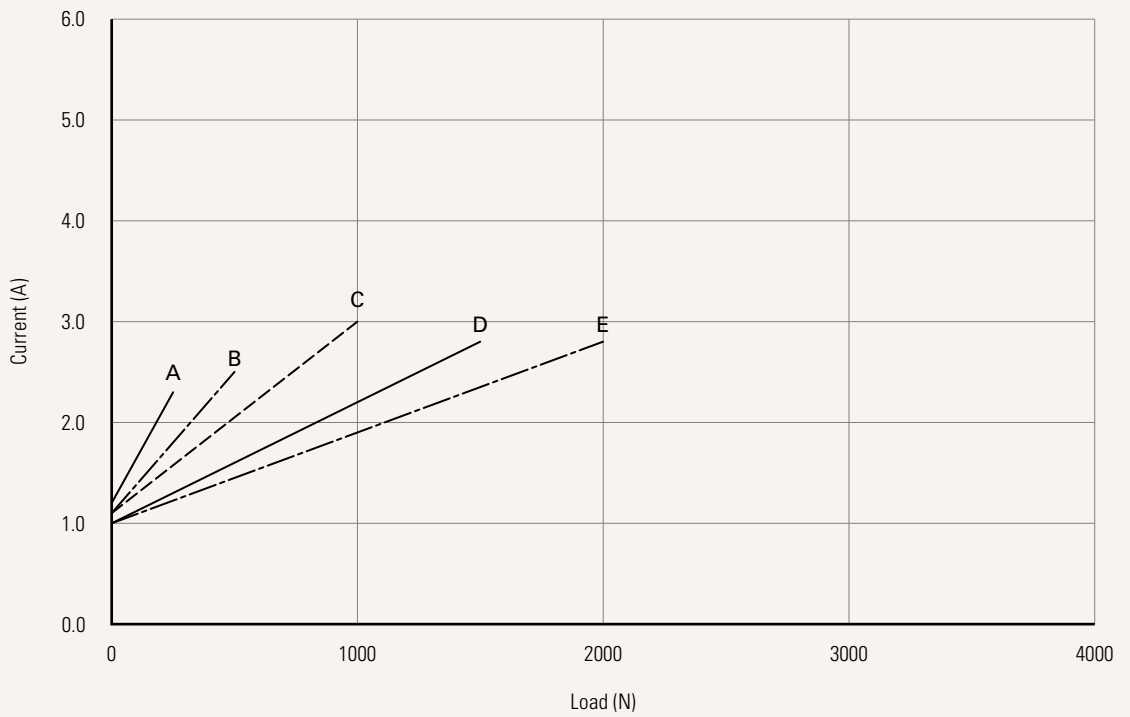

Note

1 The performance data in the curve charts shows theoretical value.

Performance Data (24V DC)

Motor Speed (6600RPM, duty cycle 25%)

Speed vs. Load

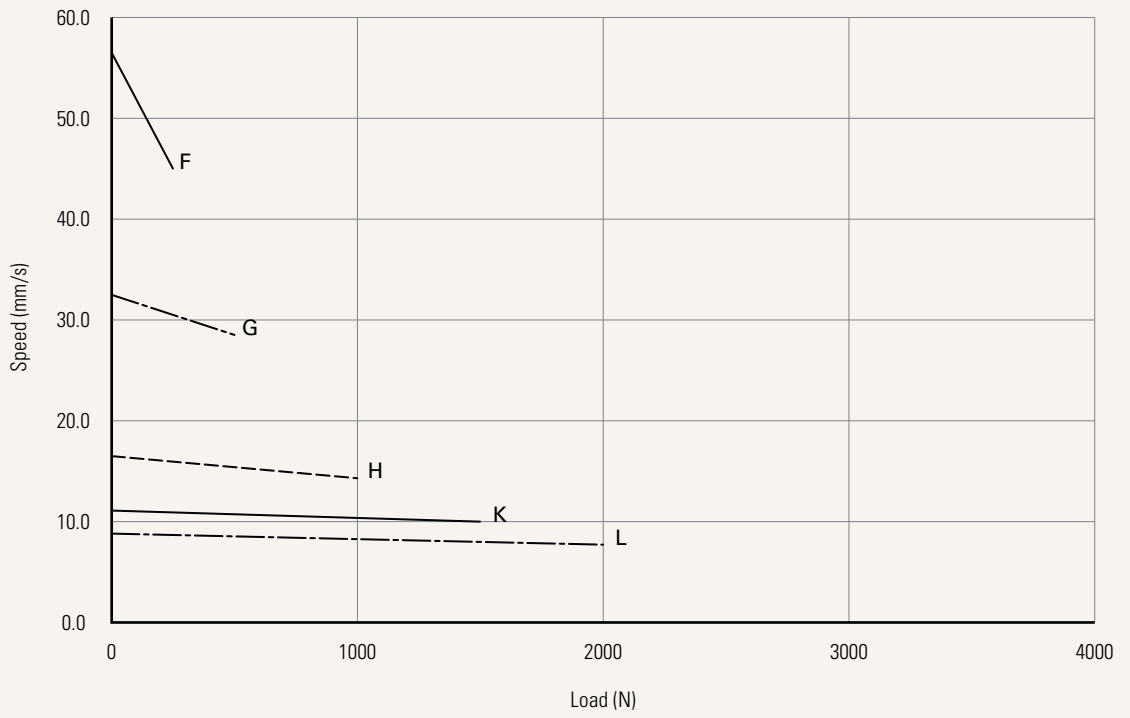

Current vs. Load

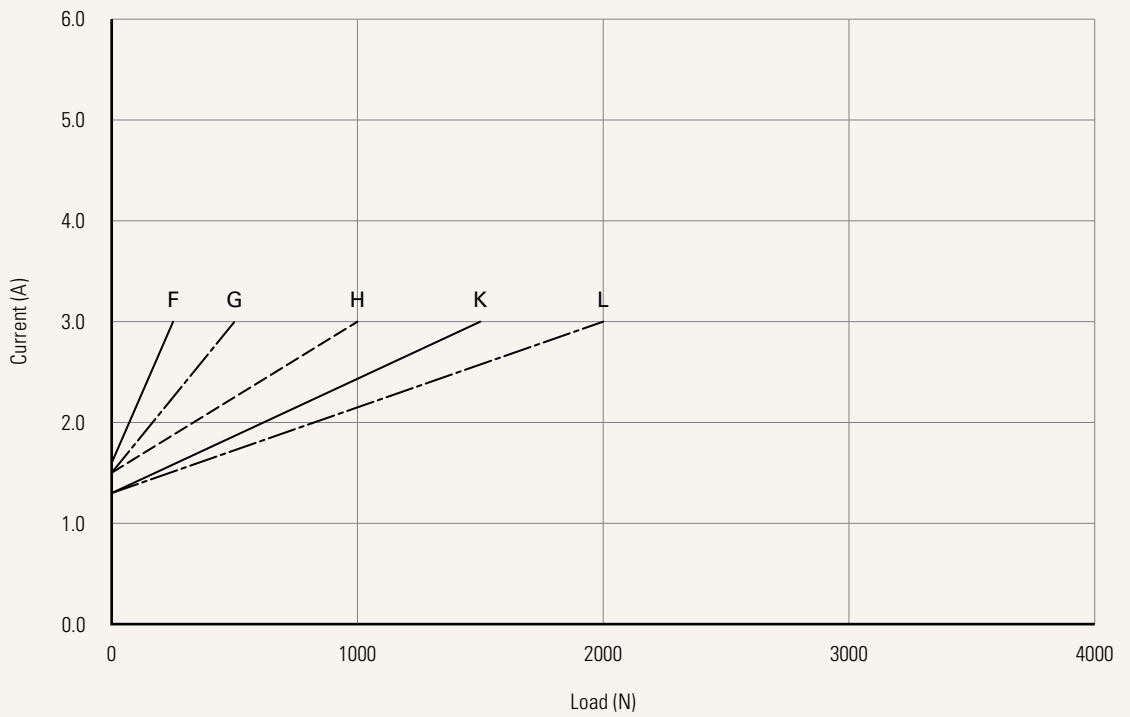

Note

1 The performance data in the curve charts shows theoretical value.

Performance Data (24V DC)

Motor Speed (3800RPM, duty cycle 25%)

Speed vs. Load

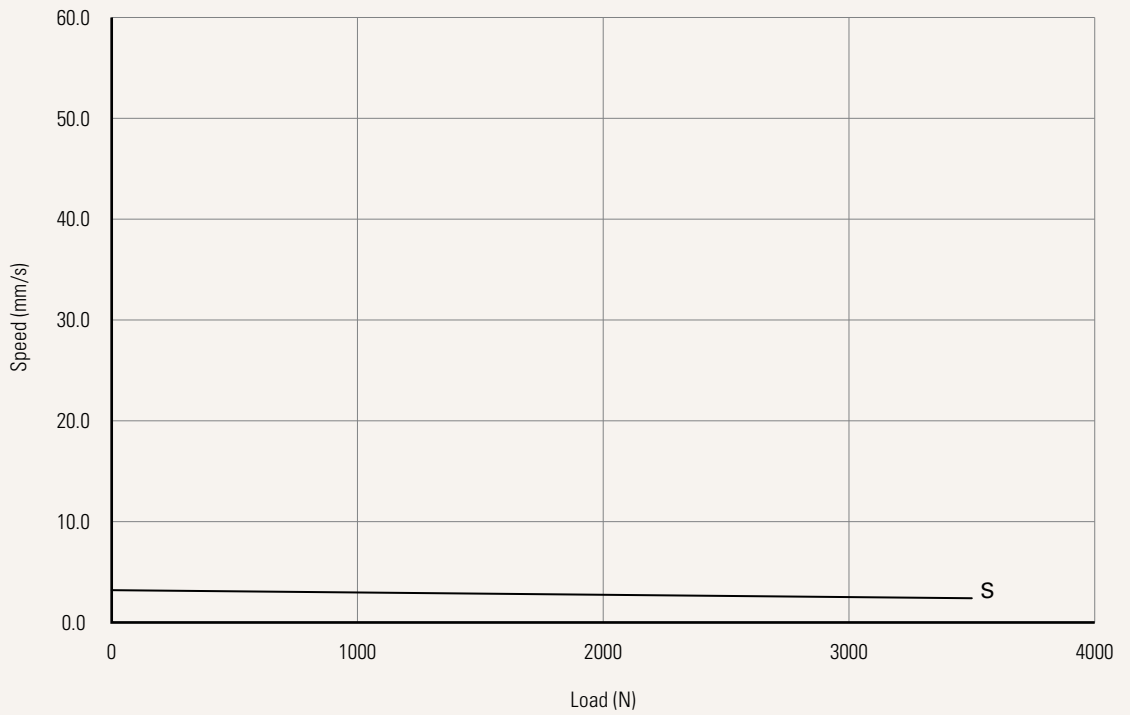

Current vs. Load

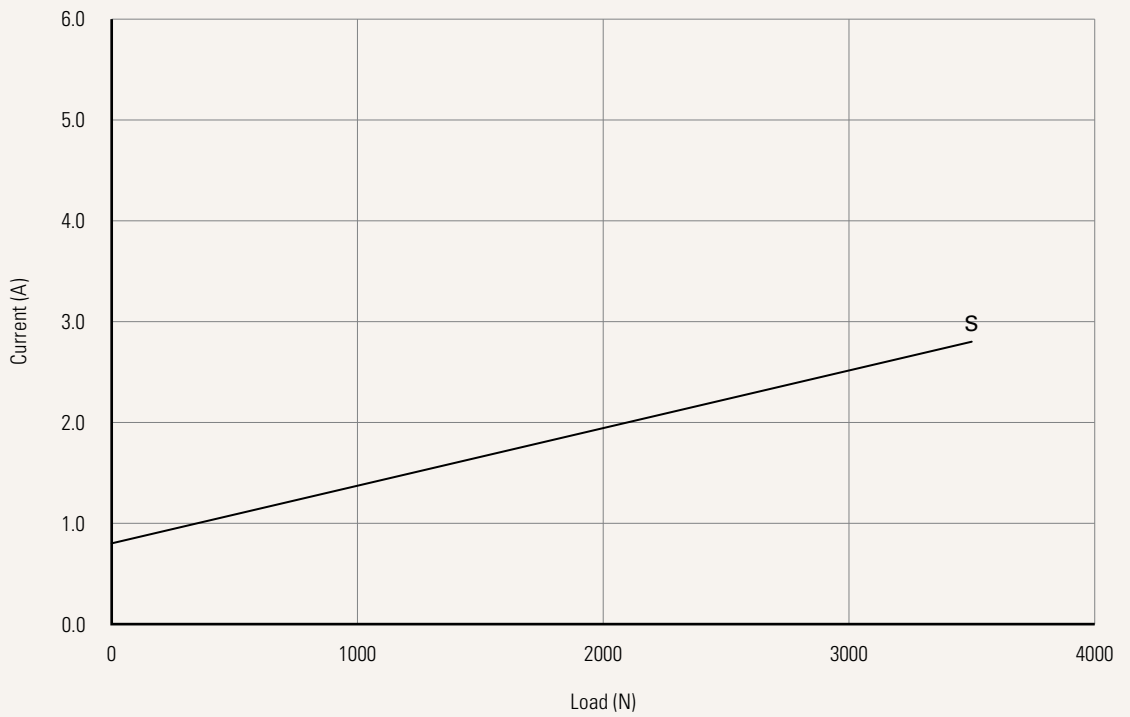

Note

1 The performance data in the curve charts shows theoretical value.

Performance Data (24V DC)

Motor Speed (2200RPM, duty cycle 25%)

Speed vs. Load

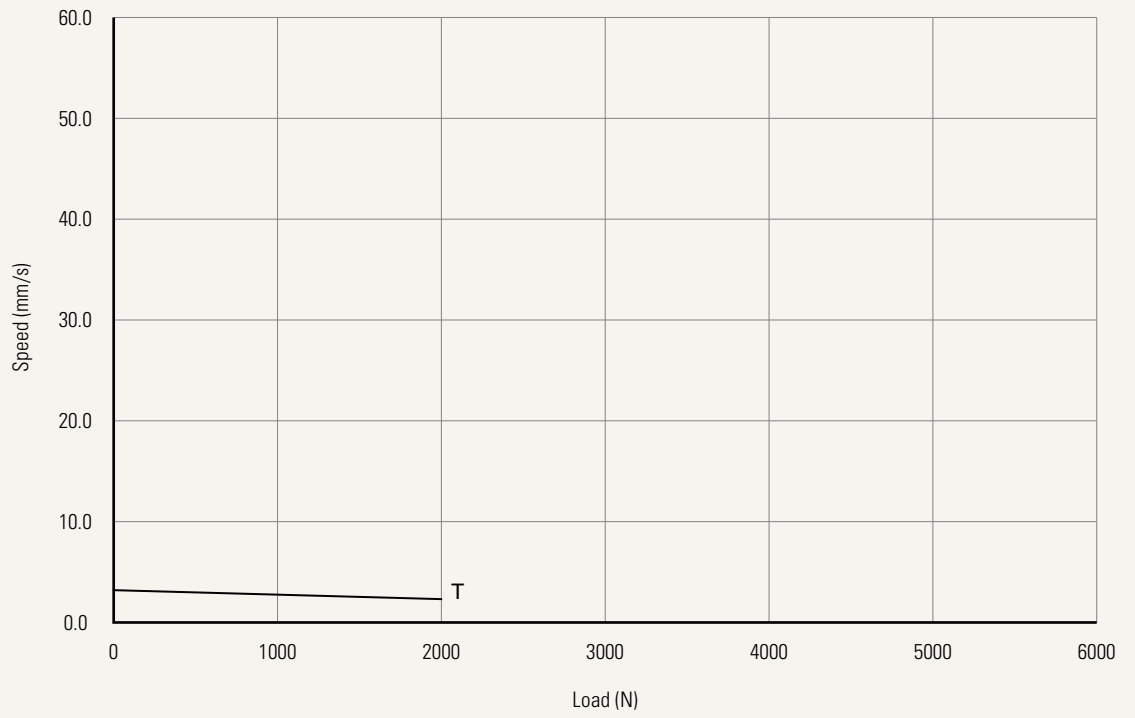

Current vs. Load

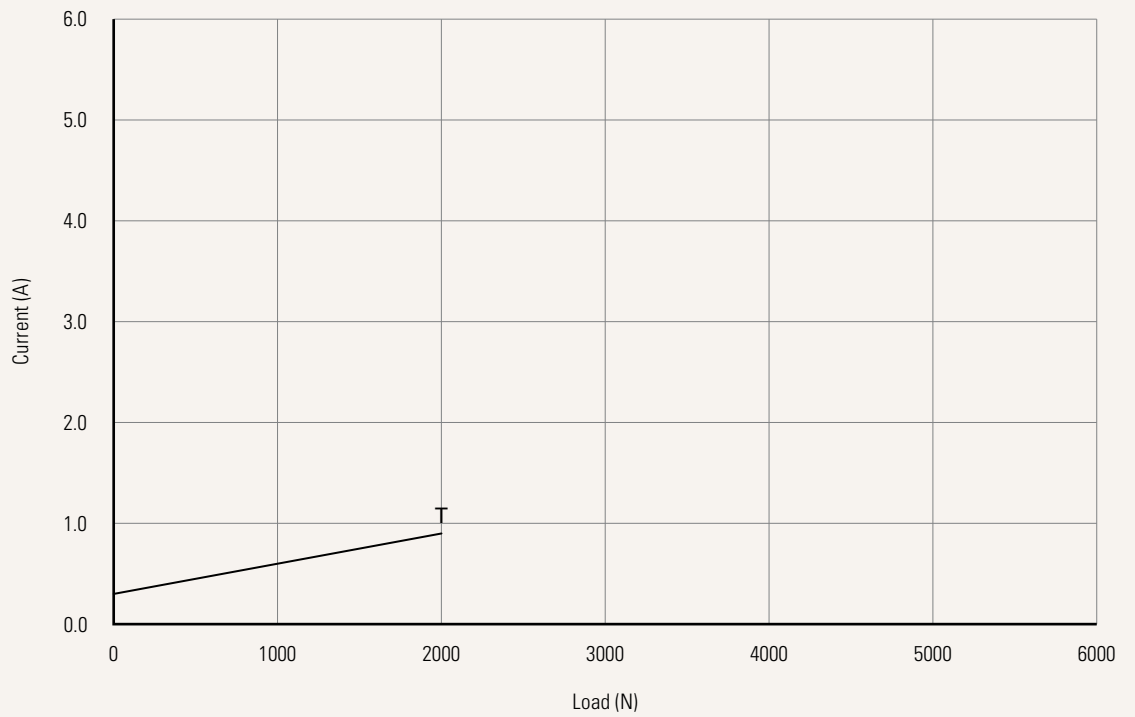

Note

1 The performance data in the curve charts shows theoretical value.

Voltage	1 = 12V DC 2 = 24V DC 3 = 36V DC	5 = 24V DC, PTC, See page 10 6 = 12V DC, PTC, See page 10		
Load and Speed	See page 3			
Stroke (mm)	See page 3			
Retracted Length (mm)	See page 9			
Rear Attachment (mm) See page 10	1 = Aluminum casting, hole 6.4, one piece casting with gear box 2 = Aluminum casting, hole 8.0, one piece casting with gear box 3 = Aluminum casting, hole 10.0, one piece casting with gear box	4 = Aluminum casting, U clevis, slot 6.0, depth 10.5, hole 6.4, one piece casting with gear box 5 = Aluminum casting, U clevis, slot 6.0, depth 10.5, hole 8.0, one piece casting with gear box 6 = Aluminum casting, U clevis, slot 6.0, depth 10.5, hole 10.0, one piece casting with gear box		
Front Attachment (mm) See page 11	1 = Aluminum casting, hole 6.4 2 = Aluminum casting, hole 8.0 3 = Aluminum CNC, U clevis, slot 6.0, depth 16.0, hole 10.0	4 = Aluminum CNC, U clevis, slot 6.0, depth 16.0, hole 6.4 5 = Aluminum CNC, U clevis, slot 6.0, depth 16.0, hole 8.0		
Direction of Rear Attachment (Counterclockwise) See page 11	1 = 90°	2 = 0°		
Functions for Limit Switches See page 11	1 = Two switches at full retracted / extended positions to cut current 2 = Two switches at full retracted / extended positions to cut current + third one in between to send signal 3 = Two switches at full retracted / extended positions to send signal 4 = Two switches at full retracted / extended positions to send signal + third one in between to send signal			
Output Signals	0 = Without	1 = POT	3 = Reed sensor	5 = Hall sensor * 2
Connector See page 12	1 = DIN 6P, 90° plug	2 = Tinned leads		
Cable Length (mm)	1 = Straight, 300	2 = Straight, 600	3 = Straight, 1000	
IP Rating	1 = Without	2 = IP54	3 = IP66	6 = IP66D

Retracted Length (mm)

1. Calculate $A+B+C = Y$
2. Retracted length needs to \geq Stroke + Y

A. Attachment		
Front Attachment	Rear Attachment	
	1, 2, 3	4, 5, 6
1, 2	+108	+112
3, 4, 5	+120	+124

B. Load V.S. Stroke		
Stroke (mm)	Load (N)	
	< 3500	= 3500
20~150	-	+5
151~200	+2	+7
201~250	+2	+7
251~300	+2	+7
301~350	+12	+17
351~400	+22	+27
401~450	+32	+37
451~500	+42	+47
501~550	+52	+57
551~600	+62	+67
601~650	+72	+77
651~700	+82	+87
701~750	+92	+97
751~800	+102	+107
801~850	+112	+117
851~900	+122	+127
901~950	+132	+137
951~1000	+142	+147

C. Output Signals	
CODE	
0, 5	-
1, 3	+30

Voltage

5 = 24V DC, PTC

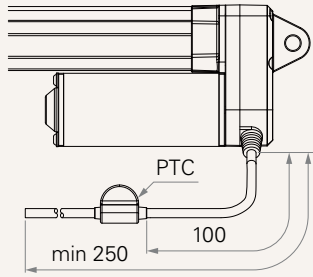

6 = 12V DC, PTC

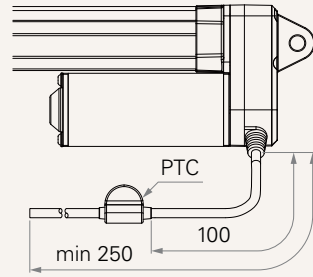

Rear Attachment (mm)

1 = Aluminum casting, hole 6.4, one piece casting with gear box

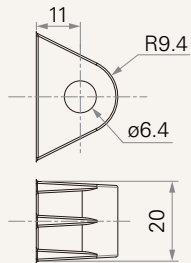

2 = Aluminum casting, hole 8.0, one piece casting with gear box

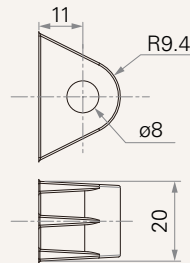

3 = Aluminum casting, hole 10.0, one piece casting with gear box

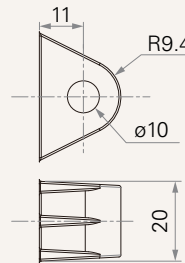

4 = Aluminum casting, U clevis, slot 6.0, depth 10.5, hole 6.4, one piece casting with gear box

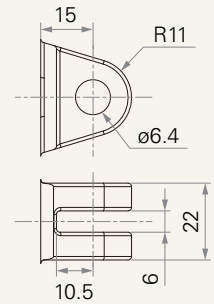

5 = Aluminum casting, U clevis, slot 6.0, depth 10.5, hole 8.0, one piece casting with gear box

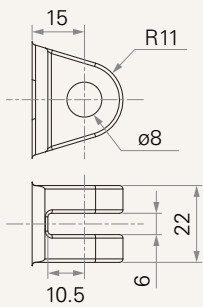

6 = Aluminum casting, U clevis, slot 6.0, depth 10.5, hole 10.0, one piece casting with gear box

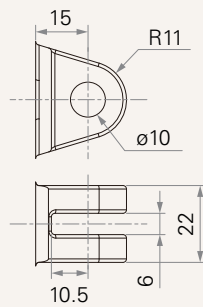

Front Attachment (mm)

1 = Aluminum casting, hole 6.4

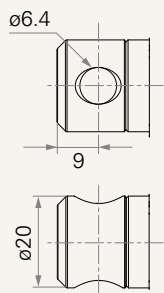

2 = Aluminum casting, hole 8.0

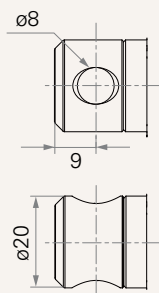

3 = Aluminum CNC, U clevis, slot 6.0, depth 16.0, hole 10.0

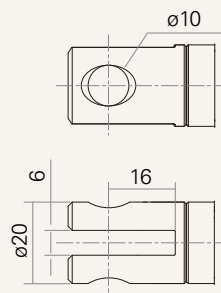

4 = Aluminum CNC, U clevis, slot 6.0, depth 16.0, hole 6.4

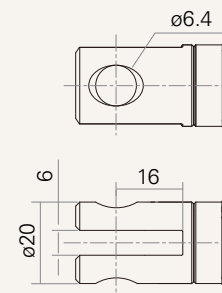

5 = Aluminum CNC, U clevis, slot 6.0, depth 16.0, hole 8.0

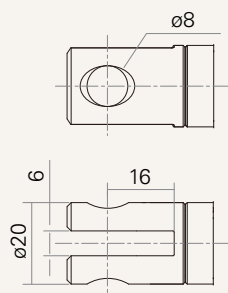

Direction of Rear Attachment (Counterclockwise)

1 = 90°

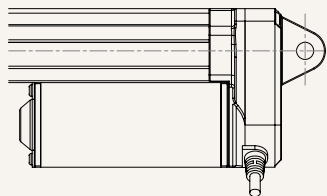

2 = 0°

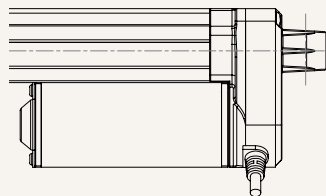

Functions for Limit Switches

Wire Definitions

CODE	Pin					
	● 1 (Green)	● 2 (Red)	○ 3 (White)	● 4 (Black)	● 5 (Yellow)	● 6 (Blue)
1	extend (VDC+)	N/A	N/A	N/A	retract (VDC+)	N/A
2	extend (VDC+)	N/A	middle switch pin B	middle switch pin A	retract (VDC+)	N/A
3	extend (VDC+)	common	upper limit switch	N/A	retract (VDC+)	lower limit switch
4	extend (VDC+)	common	upper limit switch	medium limit switch	retract (VDC+)	lower limit switch

Connector

1 = DIN 6P, 90° plug

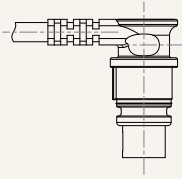

2 = Tinned leads

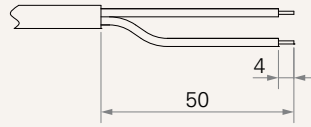

Terms of Use

The user is responsible for determining the suitability of TiMOTION products for a specific application. TiMOTION products are subject to change without prior notice.